

MAKING MODERN LIVING POSSIBLE

Danfoss



Conveyor solutions for the Beverage Industry

40 years of beverage experience

VLT[®]
THE REAL DRIVE

Conveyor solution for complete product line

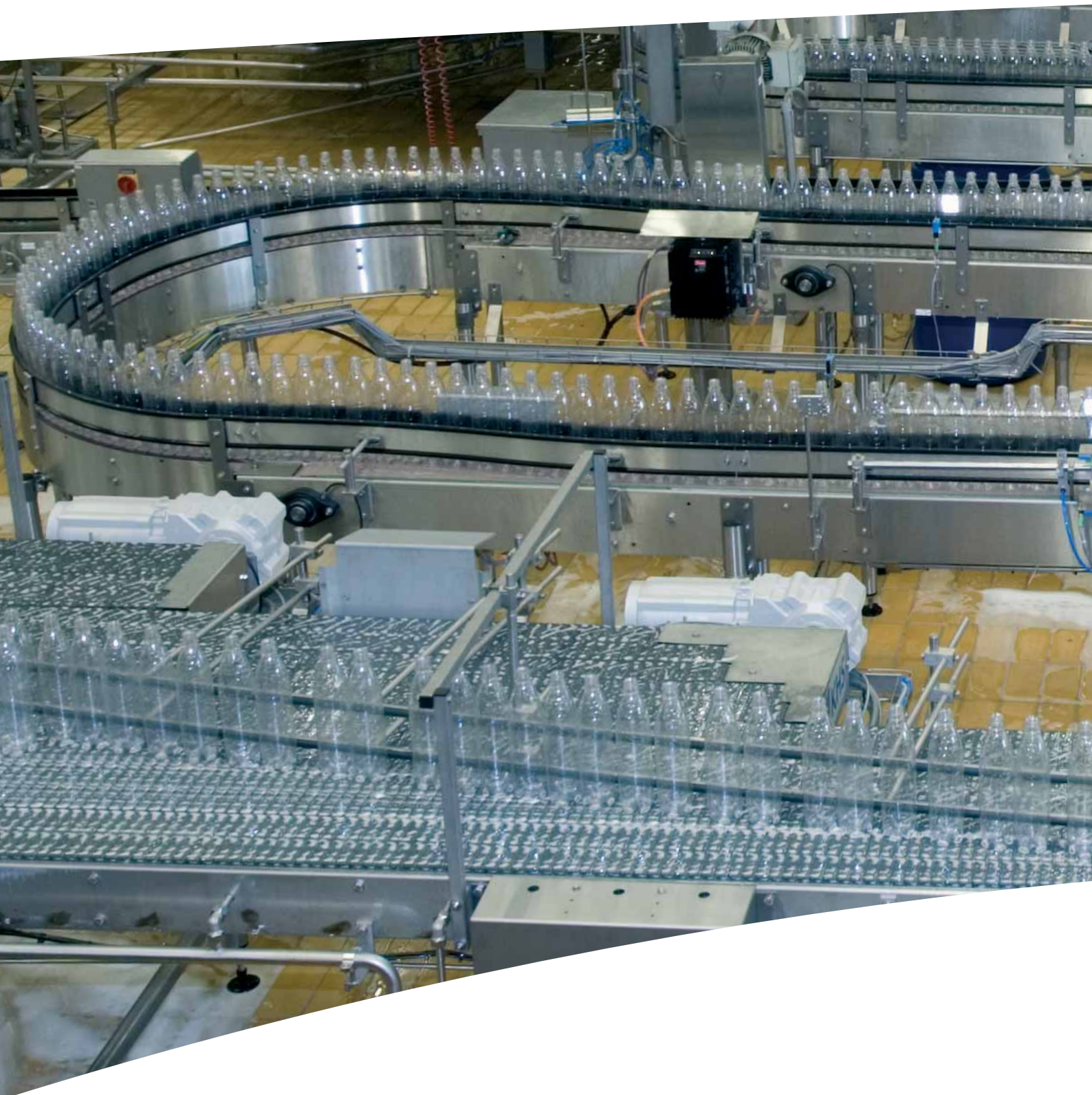

Ideal surfaces in the food industry

The demand for an optimal concept for cleaning drives and equipment has prompted a need for smooth surfaces – also those of parts and components that do not come into direct contact with the product – from which liquids can drain off and product residues can be easily removed. Surfaces should not leave any niches for pockets of dirt to form.



Preferred drives solution provider

Since 1968, when Danfoss launched the world's first frequency converters, VLT® has been the preferred drive brand among the world's leading beverage companies and Danfoss Bauer geared motors the preferred gearmotor.

Largest installed base

Danfoss has an installed base of variable speed drives in the beverage industry globally that is larger than any other supplier, and we are committed to keeping this position, providing complete drives solutions.

Expert knowlegde

Our expert knowledge of beverage processing equipment, bottling and packaging machinery, and utilities within all types of beverage industries has helped us to design and build a portfolio of products dedicated for beverage plants.

Danfoss provides highly efficient drives to control the latest PM gear motor technology.

Advanced control algorithm allows full performance, even with open loop control.

Dedicated for conveyors

- Both gear-motor and drive optimise energy efficiency (IE3)
- Less variants means less spare parts needed
- Modular design eases the concept overview
- Smooth and easy to clean surfaces on drive and motor
- One supplier eases design, ordering, installation, commissioning and service

Built to be hygienic

Both the drive and the geared motor is designed to be integrated in the plant equipment and withstand same cleaning agents and physical cleaning as the rest of the aseptic production equipment.

- Aseptic motor & Drive design
- Fan free operation, preventing airborne germs
- Robust surface treatment

Intelligent design

Only two drive footprint sizes cover the full power range, making retrofit and upgrade very easy and fast, since all wiring and looping is done in the installation part.

In few minutes the top part can be exchanged – and the production is up running – with the same or an upgraded drive.

Commisioning

Drive and motor is designed to suit each other, facilitating commissioning. The decentral VLT® drives share the awarded user interface from the Danfoss FC drives series allowing to copy settings, onboard manual, graphical LCD etc.

Maintenance/service

The components are designed for serviceability, very easy plugable concept, which reduces downtime in service cases.

The modular concept reduces the demand for spare parts.

Maximum cleanliness a key hygiene factor
Microbiologically sensitive products place high demands on hygiene in production plants to prevent any contamination by bacteria, yeasts or fungi. Manufacturers are required to provide a continuous hygiene concept for these sensitive areas.



New Danfoss Bauer HygienicDrive™

Permanent magnet synchronous motor for maximum energy efficiency

HygienicDrive™ has been designed specially for use in the food and beverage industry. Its compact design makes it predestined for use in transport and conveying systems as well as machines and equipment. The number of variants is reduced by virtue of its design concept.

This series complies with the requirements for best cleaning and hygienic design – as confirmed by the Technical University of Munich, Weihenstephan – with certification according to EHEDG (European Hygienic Engineering & Design Group).

Danfoss Bauer supplies

HygienicDrive™ with the high degrees of protection IP67 and IP69K as standard. Connection takes place using the tried and tested stainless steel circular connector system CleanConnect®.

HygienicDrive™ has all the features of the proven CleanDrive™ und AsepticDrive™ series – an absolutely smooth, easy to clean surface without cooling fins, which prevents pockets of dirt from forming and allows cleaning agents to drain off freely.

These drives do not have fans so that airborne germs and dirt particles cannot be sucked in to then be released again to the ambient air. The drive units are also available with totally encapsulated brakes and/or encoders.

The standard paint finish of the drive units is resistant to all customary cleansing agents and disinfectants with a pH of 2-12. Antibac®, an optional antimicrobial protective lacquer, is also available.

The CleanConnect® connector system can facilitate installation and prevent typical wiring errors.

Main features:

- Efficiency-optimised bevel gearing
- Special geared motors designed for optimal hygiene
- Permanent magnet excited three-phase synchronous motor Super Premium Efficiency (higher than IE3)
- High system efficiency
- High overload capacity
- Completely smooth housing leaves no niches for pockets of dirt to form and is easy to clean
- High degrees of protection IP67 and IP69K as standard
- Motor and encoder connection with Danfoss CleanConnect® stainless steel circular connector; Degrees of protection IP67 and IP69K
- Motors without cooling fins and fans ensure a measurable reduction of airborne germs
Paint finish with special lacquer coating resistant to cleansing agents and disinfectants, surface coating with FDA listed paint systems
- Available with optional Antibac® antibacterial lacquer coating
- Available hollow shaft diameters: 25, 30, 35 and 40 mm



New HygienicDrive™

This solution is a highly efficient gear-motor concept with a completely smooth surface and specially designed gearing that is seamlessly joined to the motor, which together with the motor produces a smooth surface on which no pockets of dirt can form.



- 10-pole motor for continuous duty S1
- Degrees of protection IP67 and IP69K
- Efficiency-optimised design for Super Premium Efficiency (higher than IE3) classification
- Power rating3 kW
- Speed3000 rpm
- Frequency250 Hz
- Current6,0 A
- Constants:
 - Torque $k_t = 1,7 \text{ Nm/A}$
 - Voltage $k_c = 120 \text{ V/1000 upm}$
- Thermal motor protection (PTC thermistor),
- Position detection by resolver

Speed control:

- In combination with the VLT® AutomationDrive FC302, a perfectly matched system concept
- System voltage 380 ... 500 V +/-10%
- System frequency 50/60 Hz
- Wide speed control range (output frequency 0 – 300 Hz)
- Operation with or without speed feedback (resolver option)

Speed/torque characteristic for gear ratios $i = 31.13$ and $i = 8.12$

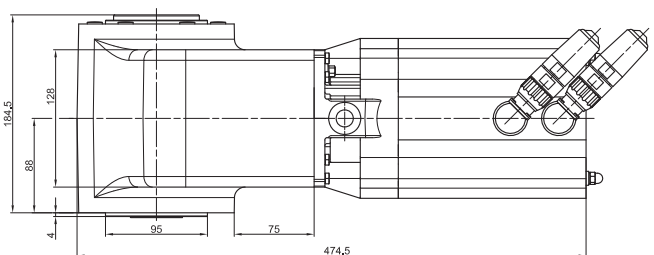
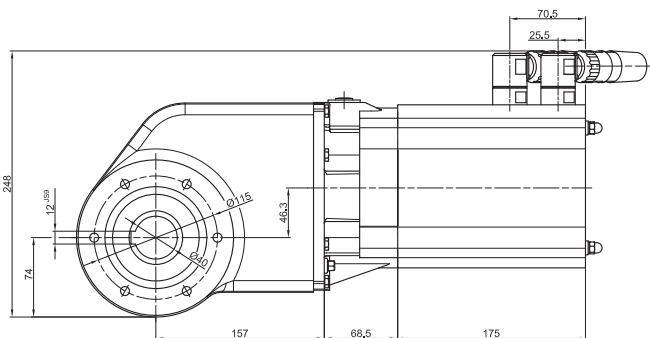
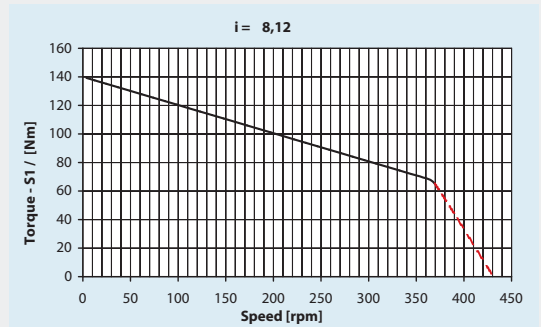
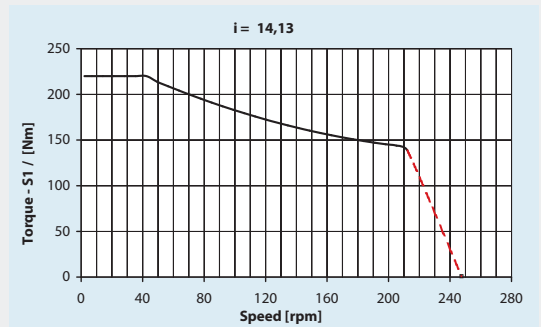
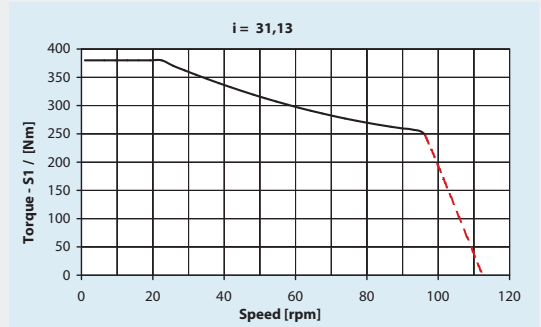

Dimensions of Danfoss Bauer HygienicDrive™

VLT® Frequency Converter

The modular VLT® Drives concept satisfies all modern motion control requirements. Even in the standard version, the VLT® AutomationDrive boasts a number of exceptional features such as VVC+ und flux-vector control, automatic motor adaption, PID controller or RS485/USB interface.

Danfoss can supply individually configured and completely assembled and tested units based on the type code. The functions of the VLT® Drive can be expanded and adapted with plug-in option modules.

Operation of permanent magnet motors

PM motors have always been used in applications demanding extreme acceleration or dynamic torque. Due to its high efficiency, slim design and size, this type of motor is now also used in other applications. The VLT® Drives supports the operation of PM



The new decentral VLT® FCD 302 is optimised for mounting near by – or on – the motor, avoiding long motor cables and allowing for modular design of the production plant.

motors with or without speed feedback. In contrast to the majority of other controllers, it must be adapted to the PM motors of various manufacturers.

This makes it suitable for application throughout the whole of production.

High system stability even in adverse environments

The VLT® AutomationDrive is available in a robust version for operation in extremely harsh or damp environments with the degrees of protection IP 55 (dust-proof/jet-proof) and IP 66 (dust-proof/protected against strong jets of water). Air cooling takes place outside the unit to prevent any contamination of the power electronics. The housing surfaces are smooth and easy to clean.

All Danfoss FC 300 units have coated (lacquered) electronic components, Class 3C2 (IEC 60721-3-3). For particularly high requirements, the user can increase the level to Class 3C3 by selecting the appropriate type code.

Total costs at a glance

The total cost of installation and operation played a key role for Danfoss in the development of the units. Specially adapted power components such as EMC filters or chokes are already integrated in the units. These reduce installation expenditure and optimise the overall efficiency. Obligatory accessories such as EMC screening plates are supplied with the units.

Integrated filters

All components such as EMC filters for Class A1/B1 according to EN 55011 as well as DC link reactors for minimising reactions on the system are compactly integrated and protected in the unit. Despite this high integration density, the VLT® AutomationDrive is very compact.

The cables are drip-proof and are fed from below through the base plate. The unit has the necessary contacts for connecting the cable screen. This means that simple and low-cost cable glands are adequate for cable routing.



Available in panel optimised versions
VLT® AutomationDrive FC 302 is available in compact versions built for panel mounting.



Energy savings in focus

Utilising energy saving potential in production plants

Today, total cost reduction and energy saving are vital for efficient production. When developing the VLT® series, Danfoss not only took into account the potential of quadratic loads such as pumps and fans, but also constant torque applications such as machine drives and conveyors.

Double savings:

Reduced power loss due to improved system efficiency

With an efficiency of up to 98% and a power factor above 0.9, VLT® series units are considerably better than comparable units. These figures already include losses for chokes and filters. This not only reduces direct energy costs for the drive as such, but also the cost of additional heat removal/air conditioning.

„AEO“ control for automatic load adaption

Automatic Energy Optimisation (AEO) enables an additional energy saving

of up to 5%. This concept optimises the current drawn by the motor to suit the current speed and given load

and supplies only the power actually needed for magnetisation and motor operation under load.

MCT 10 – Easy programming and documentation

MCT 10 software provides a PC tool to make designing, programming and documenting the entire VLT® family easier.

Universal communication

With the modular architecture of its communication layer, the MCT 10 is able to address the AutomationDrive via diverse interfaces. In addition to the standard RS-485 and USB interfaces of the VLT® drives, communication is also possible through A options such as Profibus DPV1, Profinet RT or Ethernet/IP. The software is able to address a converter through any available USB port.

Clear user interface

The MCT 10 program interface conforms to Windows standards for easy use. Parameters can be changed directly in the unit online or transferred to a PC and saved there. A comparison functions allows actual converter parameter data to be compared to previously saved data. Lists with changeable parameters can be viewed for each parameter group.

Motor database in MCT 10 software

If necessary, users can also enter asynchronous and PM motors of other manufacturers in the MCT 10 PC software.

This is done using a convenient motor database function. This enables commissioning times to be reduced to a minimum.

PC supported parameterisation
The VLT® AutomationDrive can also be commissioned and monitored with MCT 10 programming software through a USB cable or a field bus connection (PROFIBUS DPV1).



Two concepts – two sets of benefits

Whether to use central or decentral drives depends on the layout of the bottling plant, the distance from the control room to the conveyor motors and the installation cost for electrical cabinets and cables.

Decentral concept

The physical layout of many bottling halls typically require a long distance between the electrical cabinets and some of the conveyor equipment. Motor and control cables up to 100 –150 metres are thus very common.

Installation cost savings can often be achieved using a decentral drives concept:

- **Less need for central control panels/rooms**
- **Less need for screened cables**
- **Less need for cooling**

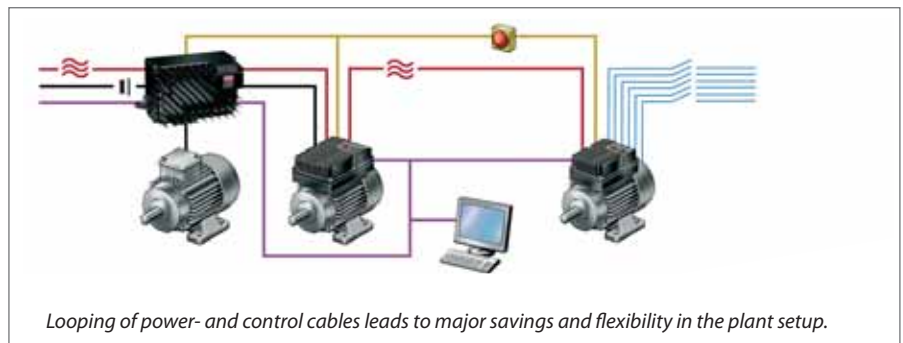

Decentral features	Benefits
• Mounted on or near the motor	– No screened cabling – Less need for cooling – Save cabinet space
• Mounted on the conveyor	– Flexible design
• Fieldbus control	– Easy setup – Coordinated operation
• Enclosure class IP 66/NEMA 4	– Suitable for wash-down areas
• Easily changed electronics	– Maximum uptime
• Decentral I/O	– Less cabling
• Automatic Motor Adaptation	– Easy commissioning
• Smooth surfaces	
• Epoxy coated surfaces	– Easy cleaning



Danfoss provides a broad range of IP 66 enclosed drives suited for mounting in production areas, exposed for humidity, dust and frequent washdowns.

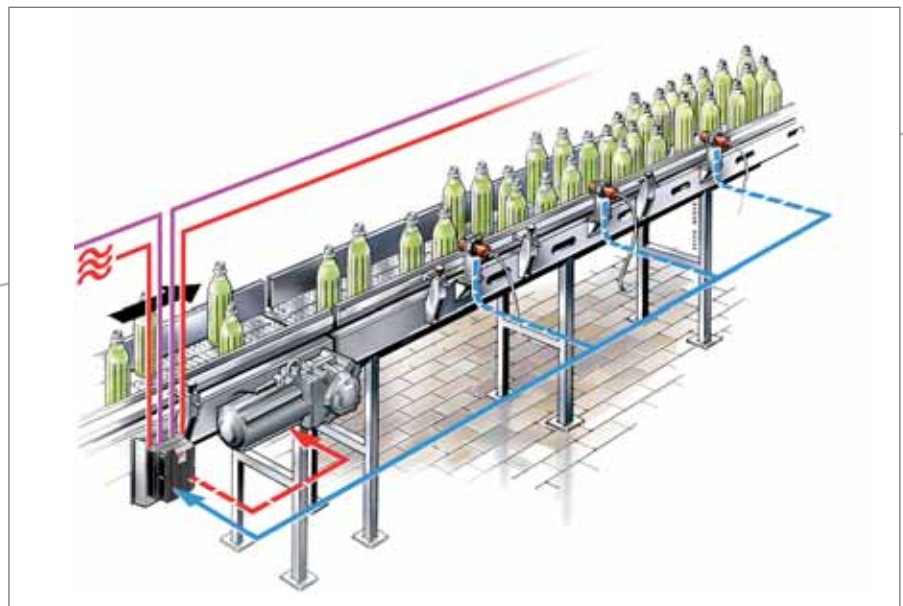

Central concept

Traditionally drives are placed in control cabinets with other control equipment.

150 metre motor cables

The long motor cables, built-in EMC filters and excellent EMC performance supports the central solution.

50° C ambient temperature

Intelligent cooling solutions

Intelligent cooling solutions, cold-plate solutions and coating solutions are available.

Real side-by-side

All central VLT® drives are designed for side-by-side mounting in ambient temperatures up to 50° C without derating.



Central features	Benefits
• Multiple I/O's	– Easy set-up and commissioning
• Remote mounting	– Low enclosure class sufficient
• Cold-plate cooling available	– No derating issue
• Rittal kit available	– Easy commissioning
• Multiple set-up	– No derating issue
• Automatic Motor Adaptation	– Flexible
• Book style concept	– Easy commissioning
• True side-by-side mounting	– Space-saving cabinet mounting

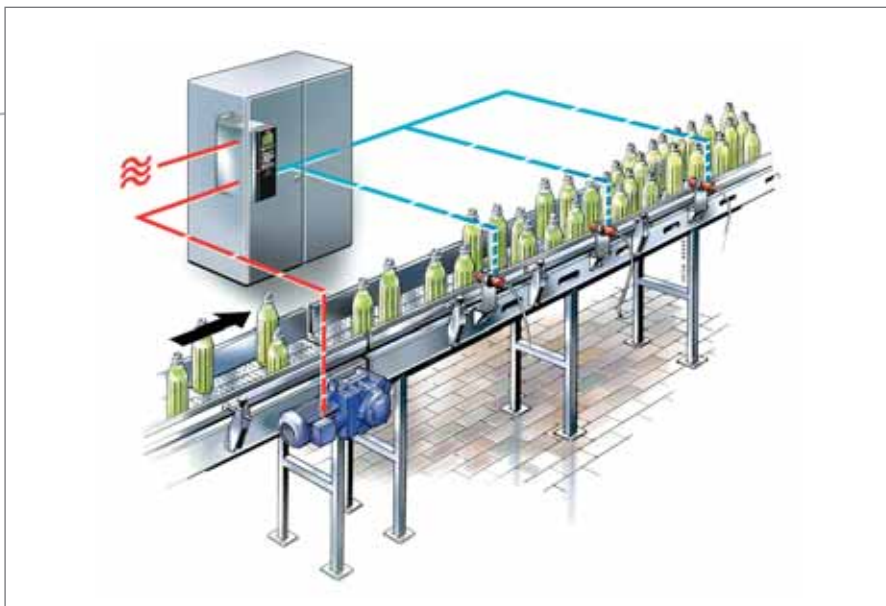

Modular concept

VLT® drives are designed for maximum customisation from the factory and maximum flexibility once installed. Choose from thousands of hardware configurations, built and tested from factory.

Upgrades and further options are a matter of plug-and-play.

Proven beverage experience



Heineken, Netherlands

The Heineken company, which traces its roots to 1864, is one of the world's leading international brewers. Available in almost every country on the planet, the Heineken brand is the most valuable international beer brand.



Asia Pacific Breweries, Singapore

Asia Pacific Breweries is an Asian brewery company founded as Malayan Breweries Limited (MBL) in 1931. It currently controls 23 breweries in 9 countries in the Asia Pacific area. Heineken is the majority shareholder with a 42.5% stake.



AmBev, Brazil

AmBev is known worldwide in the brewing industry. Possessing the largest portfolio in Brazil's brewing sector, AmBev consolidated its operation in the Brazilian beer market. Market share of the company exceeded 68.1% in 2004. Ambev is also a major producer of soft drink.



Veltins, Germany

Sorting bottles at the brewery C. & A. Veltins new plants work rapidly and reliably, due to VLT® solutions. Since the late 90's more and more different bottle shapes and colours entered the market.



Evian, France

Evian is the best selling brand of mineral water in the world, with 1.5 billion bottles sold every year, and presence on the five continents, in 125 countries. Since 1878, Evian is recognised as favourable by the Medicine academy. It has also become the preferred water in the hospital environment.



SAB Miller, South Africa

SAB Miller is the world's second largest brewery group following the acquisition of Miller Brewing. In Africa they own 44 breweries. The Alrode plant in South Africa is the largest brewery in the southern hemisphere. Capacity: 8.2 Mhl/year. Alrode uses about one thousand Danfoss drives.



Peter Lehmann Wines, Australia

Peter Lehmann Wines is one of Australia's most respected and innovative winemakers. The winery is member of the Hess Group, owner of four great wineries - Peter Lehmann Wines in the Barossa Valley, The Hess Collection Winery in the Napa Valley, Glen Carlou in South Africa and Bodega Colomé in Argentina.



Warsteiner, Germany

The new facility is not only highly efficient and environmentally friendly with a capacity for 50,000 0.5-litre or 55,000 0.33-litre glass bottles per hour; it's also designed to process other bottle sizes so that, if necessary, it can immediately respond to changing consumer requirements. VLT® made this possible.



Krombacher brewery, Germany

The Krombacher brewery is one of Europe's most modern breweries. The company's flagship brand, Krombacher Pils, Germany's best-selling beer brand, has evolved to become the area's most important ambassador far beyond its national boundaries.



Carlsberg, Denmark

Carlsberg is one of the largest brewery companies in the world, with 95 breweries in 50 countries. The group's main brand is Carlsberg supported by regional brands such as Tuborg, Baltika and Holsten. The company is now the 5th-largest brewery group in the world operating primarily in Western Europe and in growth markets in Russia, Eastern Europe and Asia.



The Drives Specialist

Danfoss Drives

Danfoss Drives is the world leader among dedicated drives providers – and still gaining market share.

Dedication has been a key word since 1968, when Danfoss introduced the world's first mass produced variable speed drive for AC motors and named it VLT®.

Two thousand employees develop, manufacture, sell and service drives and soft starters in more than one hundred countries, focused only on drives and soft starters.



Denmark:
Danfoss Drives
 Ulsnaes 1
 DK-6300 Graasten
 Tel. +45 74 88 22 22
 Fax +45 74 65 25 80,
www.danfoss.com/drives
 E-mail: info@danfoss.com

Germany:
Danfoss GmbH
VLT® Antriebstechnik
 Carl-Legien-Straße 8
 D-63073 Offenbach
 Tel. +49 69 8902-0
 Fax +49 69 8902-106
www.danfoss.de/vlt

Germany:
Danfoss Bauer GmbH
BAUER Geared Motors
 Eberhard-Bauer-Straße 36-60
 D-73734 Esslingen
 Tel. +49 711 3518-0
 Fax +49 711 3518-381
www.danfoss-bauer.com

Austria:
Danfoss Gesellschaft m. b. H.
VLT® Antriebstechnik
 Danfoss Straße 8
 A-2353 Guntramsdorf
 Tel. +43 2236 5040
 Fax +43 2236 5040-35
www.danfoss.at/vlt

Switzerland:
Danfoss AG
VLT® Antriebstechnik
 Parkstrasse 6
 CH-4402 Frenkendorf
 Tel. +41 61 906 11 11
 Fax +41 61 906 11 21
www.danfoss.ch

